

KTN

KETTING TECHNIEK NEDERLAND B.V.

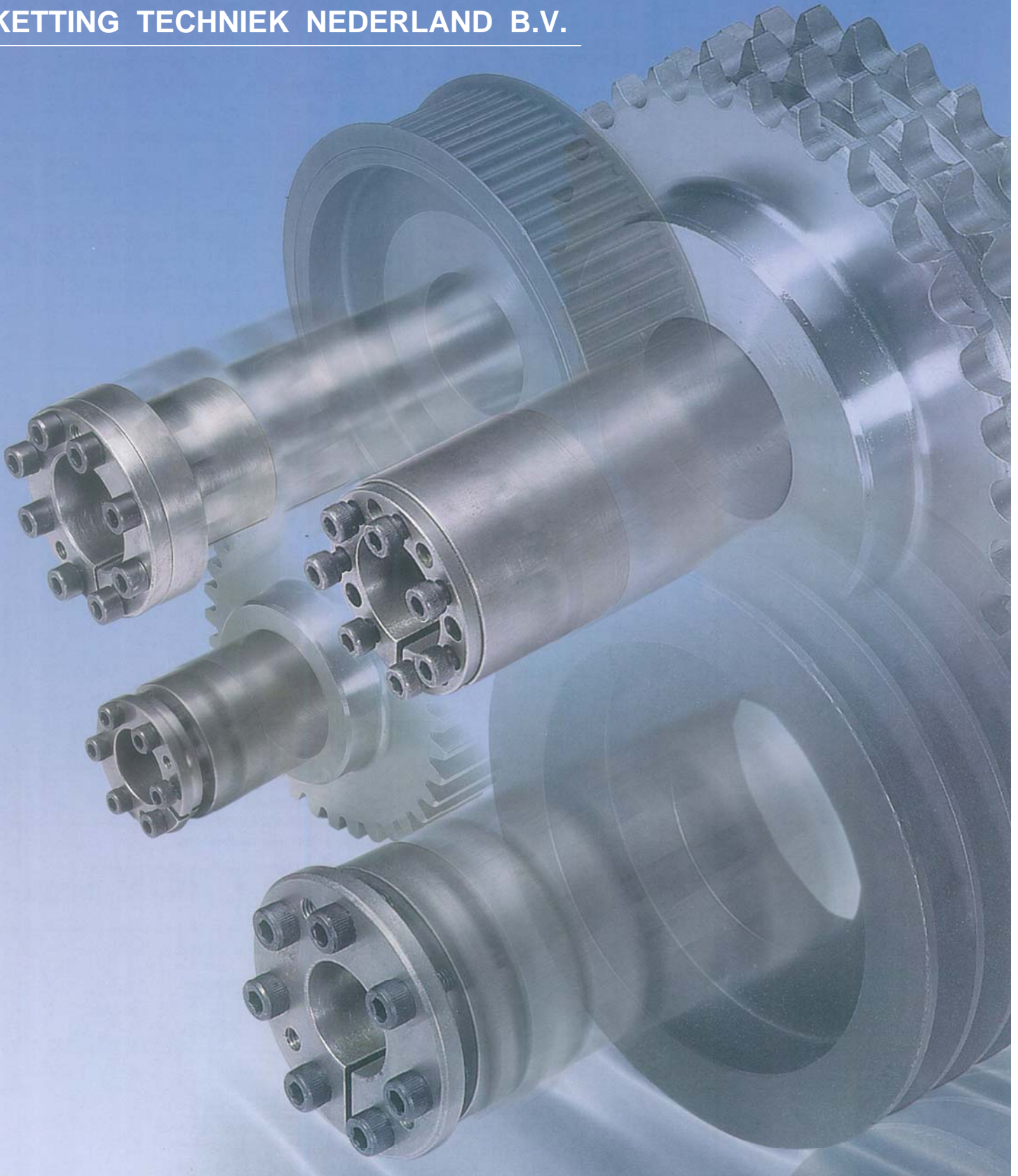

SPANBUSSEN - LOCKING DEVICES

SPANBUSSEN

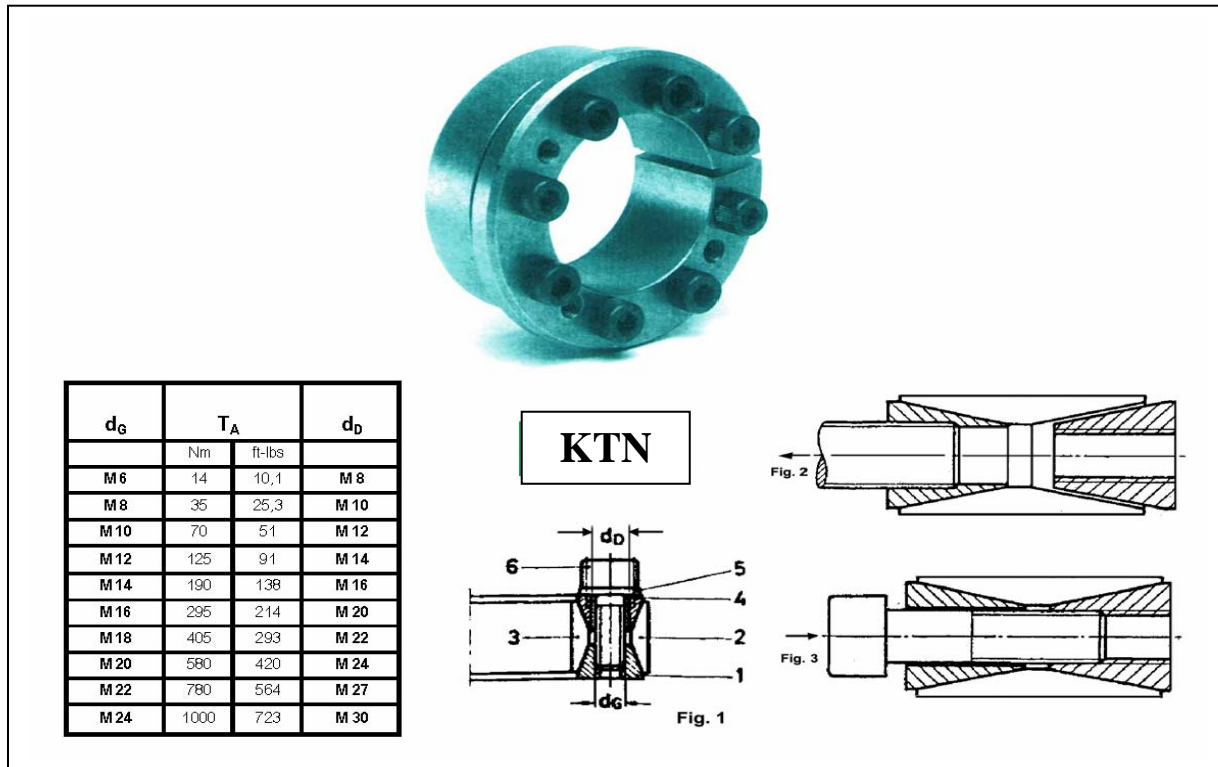

MONTAGE

De krachtoverdracht vindt plaats door druk op de wrijvingsvlakken van de spansets, as en naaf uit te oefenen. Daarom moet er speciaal op gelet worden, dat de spanschroeven zijn aangedraaid met het voorgeschreven moment en dat de wrijvingsvlakken aan de eisen voldoen (zie tabel).

1- Alle wrijvingsvlakken, inclusief draad en schroefkoppen moeten schoon en licht geolied zijn. As, naaf en spanset in deze toestand monteren.

2- Spanschroeven licht aandraaien en naaf richten.

3- Schroeven in twee tot drie etappes gelijkmatig en kruiselings aantrekken tot het voorgeschreven aanhaalmoment (TA) is bereikt

4- De aanhaalmomenten van de schroeven controleren in rondgaande volgorde. Pas wanneer alle spanschroeven het vereiste moment hebben is de montage voltooid.

Alvorens reeds gebruikte KTN-spansets te monteren deze eerst schoonmaken, licht inoliën en daarna volgens fig. 1 weer in elkaar zetten. De drie gemerkte schroeven worden voorzien van sluitringen, ze dienen te worden geplaatst in die doorlopende gaten, waarin draad is getapt (dD), als hulpschroefdraad bij demontage.

Opgelet:

Schroeven goed inoliën! Gebruik geen smeermiddelen, die molybdeen-disulfide bevatten!

Maximum toegelaten toleranties :

As diameter : h8
Boring : H8

DEMONTAGE

1- Spanschroeven gelijkmatig en kruiselings in meerdere etappes losdraaien.

2- De losgedraaide verbinding kan nu opnieuw ingesteld of uit elkaar genomen worden. Indien de KTN-spanset vastgeklemd zit, de voorste en achterste drukring lossen volgens fig. 2 en fig. 3

De hulpschroefdraden voor demontage hebben slechts 3-5 dragende gangen en zijn derhalve niet geschikt voor het overbrengen van grote krachten. In deze schroefdraad gemonteerde schroeven kunnen de demontage vergemakkelijken.

Pos 1: achterste drukring

Pos 2: buitenring

Pos 3: binnenring

Pos 4: voorste drukring

Pos 5: sluitring

Pos 6: spanschroef kwaliteit 12.9

TYPE KTN 11

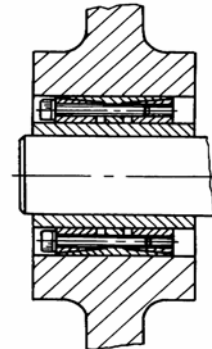
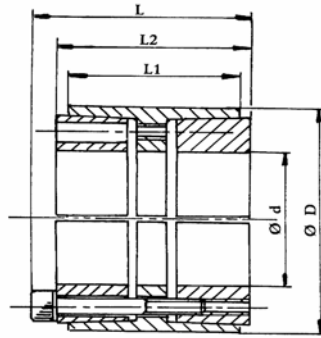

Dimensions of locking device				Torque	Surface pressure		Screws		
ø d x ø D	L1	L2	L		Nm	Shaft h8	Hub H8	per DIN 912 Mat. 12.9	
				N/mm ²		N/mm ²	N°	Type	Nm
25 x 55	32	40	46	784	291	99	6	M6 x 35	17
28 x 55	32	40	46	882	259	99	6	M6 x 35	17
30 x 55	32	40	46	931	243	99	6	M6 x 35	17
35 x 60	44	54	60	1274	161	85	7	M6 x 45	17
38 x 75	44	54	62	2696	289	113	7	M8 x 50	41
40 x 75	44	54	62	2843	276	113	7	M8 x 50	41
42 x 75	44	54	62	2981	262	113	7	M8 x 50	41
45 x 75	44	54	62	3196	246	113	7	M8 x 50	41
48 x 80	44	54	62	3873	203	96	8	M8 x 50	41
50 x 80	56	64	72	4069	196	96	8	M8 x 50	41
55 x 85	56	64	72	5050	201	101	9	M8 x 50	41
60 x 90	56	64	72	6080	198	103	10	M8 x 50	41
65 x 95	56	64	72	6619	183	98	10	M8 x 50	41
70 x 110	70	78	88	11277	218	111	10	M10 x 60	83
75 x 115	70	78	88	12062	218	111	10	M10 x 60	83
80 x 120	70	78	88	14219	210	112	11	M10 x 60	83
85 x 125	70	78	88	15102	210	112	12	M10 x 60	83
90 x 130	70	78	88	17455	203	112	12	M10 x 60	83
95 x 135	70	78	88	18338	203	112	12	M10 x 60	83
100 x 145	90	100	112	25791	196	104	11	M12 x 80	145
110 x 155	90	100	112	31184	194	107	12	M12 x 80	145
120 x 165	90	100	112	39618	207	117	14	M12 x 80	145
130 x 180	104	116	130	50503	188	109	12	M14 x 90	230
140 x 190	104	116	130	63470	204	121	14	M14 x 90	230
150 x 200	104	116	130	72790	204	124	15	M14 x 90	230
160 x 210	104	116	130	82890	204	125	16	M14 x 90	230
170 x 225	134	148	164	106000	178	110	14	M16 x 110	355
180 x 235	134	148	164	120900	180	112	15	M16 x 110	355
190 x 250	134	148	164	131250	182	113	16	M16 x 110	355
200 x 260	134	148	164	143220	173	110	16	M16 x 110	355
220 x 285	134	148	164	177560	184	112	18	M16 x 110	355
240 x 305	134	148	164	213850	180	116	20	M16 x 110	355
260 x 325	134	148	164	245250	174	114	21	M16 x 110	355
280 x 355	165	177	197	353160	181	115	18	M20 x 130	690
300 x 375	165	177	197	419860	188	120	20	M20 x 130	690

SPANBUSSEN

TYPE KTN 13

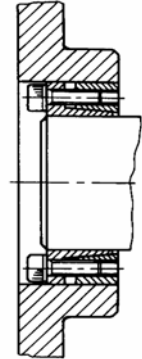
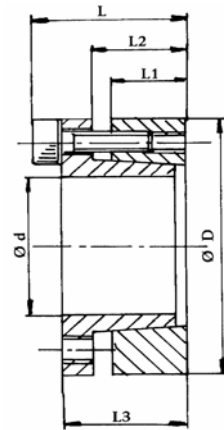
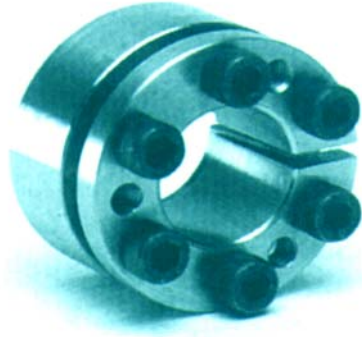

Dimensions of locking device					Torque Nm	Surface pressure		Screws		
ø d x ø D	L1	L2	L3	L		Shaft h8	Hub H8	per DIN 912 Mat. 12.9		
					N/mm ²	N/mm ²	N°	Type	Nm	
18 x 47	17	22	28	34	350	280	120	5	M6 x 20	14
19 x 47	17	22	28	34	355	280	120	5	M6 x 20	14
20 x 47	17	22	28	34	360	280	120	5	M6 x 20	14
22 x 47	17	22	28	34	400	268	123	5	M6 x 20	14
24 x 50	17	22	28	34	440	243	120	6	M6 x 20	14
25 x 50	17	22	28	34	560	280	138	6	M6 x 20	14
28 x 55	17	22	28	34	625	250	128	6	M6 x 20	14
30 x 55	17	22	28	34	650	235	128	6	M6 x 20	14
32 x 60	17	22	28	34	950	290	150	8	M6 x 20	14
35 x 60	17	22	28	34	1050	268	150	8	M6 x 20	14
38 x 65	17	22	28	34	1140	252	146	8	M6 x 20	14
40 x 65	17	22	28	34	1200	232	146	8	M6 x 20	14
45 x 75	20	25	33	41	2180	285	168	7	M8 x 25	35
50 x 80	20	25	33	41	2430	258	158	7	M8 x 25	35
55 x 85	20	25	33	41	3050	268	173	8	M8 x 25	35
60 x 90	20	25	33	41	3350	243	163	8	M8 x 25	35
65 x 95	20	25	33	41	4080	253	173	9	M8 x 25	35
70 x 110	24	30	40	50	6280	278	178	8	M10 x 30	70
75 x 115	24	30	40	50	6680	258	168	8	M10 x 30	70
80 x 120	24	30	40	50	7130	248	168	8	M10 x 30	70
85 x 125	24	30	40	50	8450	258	178	9	M10 x 30	70
90 x 130	24	30	40	50	9080	248	168	9	M10 x 30	70
95 x 135	24	30	40	50	10580	258	178	10	M10 x 30	70
100 x 145	26	32	44	56	13380	268	188	8	M12 x 35	125
110 x 155	26	32	44	56	14580	238	178	8	M12 x 35	125
120 x 165	26	32	44	56	17880	248	178	9	M12 x 35	125
130 x 180	34	40	52	64	25950	238	168	12	M12 x 35	125
140 x 190	34	40	54	68	26950	208	148	9	M14 x 40	190
150 x 200	34	40	54	68	32950	228	168	10	M14 x 40	190
160 x 210	34	40	54	68	37900	228	168	11	M14 x 40	190
170 x 225	44	50	64	78	44900	188	128	12	M14 x 40	190
180 x 235	44	50	64	78	46900	168	128	12	M14 x 40	190

TYPE KTN 15

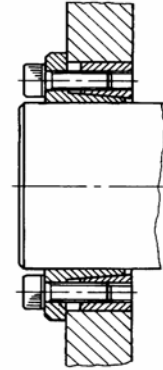
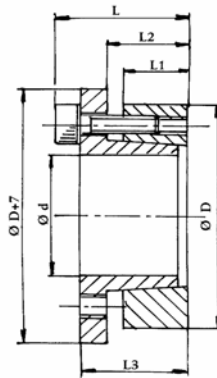
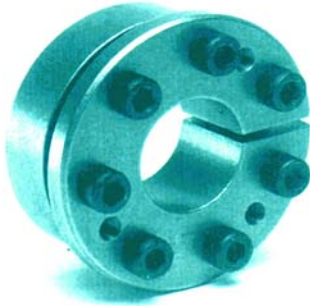

Dimensions of locking device					Torque Nm	Surface pressure		Screws		
ø d x ø D	L1	L2	L3	L		Shaft h8	Hub H8	per DIN 912 Mat. 12.9		
					N/mm ²	N/mm ²	N°	Type	Nm	
14 x 55	17	22	31	39	282	458	118	4	M8 x 25	41
16 x 55	17	22	31	39	313	400	118	4	M8 x 25	41
18 x 55	17	22	31	39	353	356	118	4	M8 x 25	41
19 x 55	17	22	31	39	372	337	118	4	M8 x 25	41
20 x 55	17	22	31	39	392	320	118	4	M8 x 25	41
22 x 55	17	22	31	39	431	290	118	4	M8 x 25	41
24 x 55	17	22	31	39	470	265	118	4	M8 x 25	41
25 x 55	17	22	31	39	490	255	118	4	M8 x 25	41
28 x 55	17	22	31	39	549	228	118	4	M8 x 25	41
30 x 55	17	22	31	39	588	213	118	4	M8 x 25	41
24 x 65	17	22	31	39	617	332	122	5	M8 x 25	41
25 x 65	17	22	31	39	637	320	122	5	M8 x 25	41
28 x 65	17	22	31	39	725	285	122	5	M8 x 25	41
30 x 65	17	22	31	39	764	267	122	5	M8 x 25	41
32 x 65	17	22	31	39	823	250	122	5	M8 x 25	41
35 x 65	17	22	31	39	902	228	122	5	M8 x 25	41
38 x 65	17	22	31	39	970	210	122	5	M8 x 25	41
40 x 65	17	22	31	39	1029	200	122	5	M8 x 25	41
30 x 80	20	25	33	41	1082	315	120	7	M8 x 25	41
32 x 80	20	25	33	41	1155	298	120	7	M8 x 25	41
35 x 80	20	25	33	41	1260	272	120	7	M8 x 25	41
38 x 80	20	25	33	41	1370	250	120	7	M8 x 25	41
40 x 80	20	25	33	41	1440	238	120	7	M8 x 25	41
42 x 80	20	25	33	41	1510	226	120	7	M8 x 25	41
45 x 80	20	25	33	41	1620	212	120	7	M8 x 25	41
48 x 80	20	25	33	41	1735	198	120	7	M8 x 25	41
50 x 80	20	25	33	41	1806	190	120	7	M8 x 25	41
40 x 80	20	25	33	41	2157	340	169	10	M8 x 25	41
45 x 80	20	25	33	41	2422	302	169	10	M8 x 25	41
50 x 80	20	25	33	41	2700	272	169	10	M8 x 25	41

TYPE KTN 16

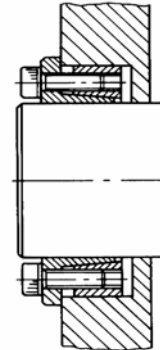
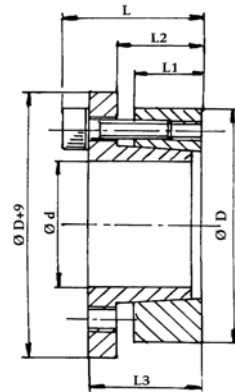
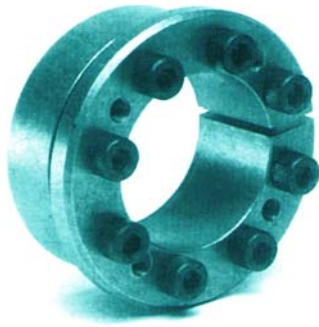

Dimensions of locking device					Torque Nm	Surface pressure		Screws		
ø d x ø D	L1	L2	L3	L		Shaft h8	Hub H8	per DIN 912 Mat. 12.9		
						N/mm ²	N/mm ²	N°	Type	Nm
18 x 47	17	22	28	34	264	215	93	5	M6 x 20	17
19 x 47	17	22	28	34	274	215	93	5	M6 x 20	17
20 x 47	17	22	28	34	284	215	93	5	M6 x 20	17
22 x 47	17	22	28	34	314	196	93	5	M6 x 20	17
24 x 50	17	22	28	34	401	215	107	6	M6 x 20	17
25 x 50	17	22	28	34	441	210	107	6	M6 x 20	17
28 x 55	17	22	28	34	490	196	98	6	M6 x 20	17
30 x 55	17	22	28	34	529	186	98	6	M6 x 20	17
32 x 60	17	22	28	34	755	210	112	8	M6 x 20	17
35 x 60	17	22	28	34	824	186	107	8	M6 x 20	17
38 x 65	17	22	28	34	892	191	112	8	M6 x 20	17
40 x 65	17	22	28	34	941	186	102	8	M6 x 20	17
45 x 75	20	25	33	41	1716	225	132	7	M8 x 25	41
50 x 80	20	25	33	41	1893	205	127	7	M8 x 25	41
55 x 85	20	25	33	41	2403	210	132	8	M8 x 25	41
60 x 90	20	25	33	41	2648	186	122	8	M8 x 25	41
65 x 95	20	25	33	41	3188	196	132	9	M8 x 25	41
70 x 110	24	30	40	50	4905	215	137	8	M10 x 30	83
75 x 115	24	30	40	50	5150	195	127	8	M10 x 30	83
80 x 120	24	30	40	50	5490	185	122	8	M10 x 30	83
85 x 125	24	30	40	50	6620	195	132	9	M10 x 30	83
90 x 130	24	30	40	50	6960	185	127	9	M10 x 30	83
95 x 135	24	30	40	50	8190	195	137	10	M10 x 30	83
100 x 145	26	32	44	56	10100	205	145	8	M12 x 35	145
110 x 155	26	32	44	56	11030	190	135	8	M12 x 35	145
120 x 165	26	32	44	56	13600	205	142	9	M12 x 35	145
130 x 180	34	40	52	64	19000	186	137	12	M12 x 35	145
140 x 190	34	40	54	68	21800	177	127	9	M14 x 40	230
150 x 200	34	40	54	68	25600	185	137	10	M14 x 40	230
160 x 210	34	40	54	68	30200	185	140	11	M14 x 40	230
170 x 225	44	50	64	78	35000	147	110	12	M14 x 40	230
180 x 235	44	50	64	78	37000	142	108	12	M14 x 40	230

SPANBUSSEN

TYPE KTN 19

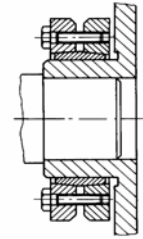
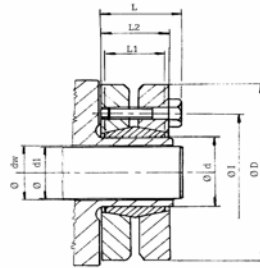
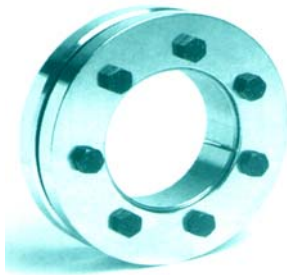

Dimensions of locking device							Torque Nm	Surface pressure		Screws		
$\varnothing d \times \varnothing D$	$\varnothing dw$	L1	L2	L	$\varnothing I$	Δdw ($dw-d1$)		Shaft h8 N/mm ²		per DIN 912 Mat.12.9		
									N°	Type	Nm	
24 x 50	19	14	19,5	23	36	0,017	170	286	6	M5 x 18	4	
	20						210					
	21						250					
30 x 60	24	16	21,5	25	44	0,017	300	233	7	M5 x 18	4	
	25						340					
	26						380					
36 x 72	28	18	23,5	27,5	52	0,032	440	307	5	M6 x 20	12	
	30						570					
	31						630					
44 x 80	32	20	25,5	29,5	61	0,032	620	317	7	M6 x 20	12	
	35						780					
	36						860					
50 x 90	38	22	27,5	31,5	70	0,032	940	289	8	M6 x 25	12	
	40						1160					
	42						1380					
55 x 100	42	23	30,5	34,5	75	0,032	1160	252	8	M6 x 25	12	
	45						1520					
	48						1880					
62 x 110	48	23	30,5	34,5	86	0,048	1850	279	10	M6 x 25	12	
	50						2200					
	52						2400					
68 x 115	50	23	30,5	34,5	86	0,048	2000	255	10	M6 x 25	12	
	55						2500					
	60						3150					
75 x 138	55	25	32,5	37,8	100	0,048	2500	273	7	M8 x 30	30	
	60						3200					
	65						3950					
80 x 145	60	25	32,5	37,8	100	0,048	3200	256	7	M8 x 30	30	
	65						3900					
	70						4600					
90 x 155	65	30	39	44,3	114	0,048	4750	271	10	M8 x 35	30	
	70						6000					
	75						7250					
100 x 170	70	34	44	49,3	124	0,048	6900	258	12	M8 x 35	30	
	75						7500					
	80						9000					
110 x 185	75	39	50	56,4	136	0,048	7200	244	9	M10 x 40	59	
	80						9000					
	85						10800					
125 x 215	85	42	54	60,4	160	0,069	11000	266	12	M10 x 40	59	
	90						13000					
	95						15000					
140 x 230	95	46	60,5	68	175	0,069	15100	264	10	M12 x 45	100	
	100						17600					
	105						20100					
155 x 265	105	50	64,5	72	192	0,069	22000	263	12	M12 x 50	100	
	110						25000					
	115						28000					
165 x 290	115	56	71	81	210	0,069	31000	277	8	M16 x 55	250	
	120						35000					
	125						39000					

TYPE KTN 40

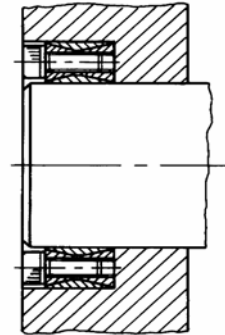
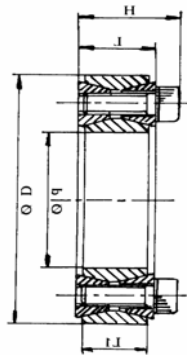
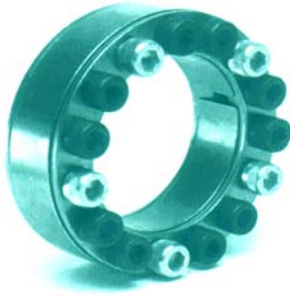

Dimensions of locking device				Torque	Surface pressure		Screws		
ø d x ø D	L1	L	H		Nm	Shaft h8	Hub H8	per DIN 912 Mat. 12.9	
				N/mm ²		N/mm ²	N°	Type	Nm
19 x 47	17	20	28	290	235	90	8	M6 x 18	15
20 x 47	17	20	28	295	208	90	8	M6 x 18	15
22 x 47	17	20	28	320	192	89	8	M6 x 18	15
24 x 50	17	20	28	370	192	94	9	M6 x 18	15
25 x 50	17	20	28	390	187	94	9	M6 x 18	15
28 x 55	17	20	28	490	153	94	10	M6 x 18	15
30 x 55	17	20	28	520	173	94	10	M6 x 18	15
32 x 60	17	20	28	680	205	105	12	M6 x 18	15
35 x 60	17	20	28	710	180	105	12	M6 x 18	15
38 x 65	17	20	28	880	176	108	14	M6 x 18	15
40 x 65	17	20	28	930	176	108	14	M6 x 18	15
42 x 75	20	24	34	1580	235	123	12	M8 x 22	37
45 x 75	20	24	34	1620	206	123	12	M8 x 22	37
48 x 80	20	24	34	1690	186	108	12	M8 x 22	37
50 x 80	20	24	34	1770	187	113	12	M8 x 22	37
55 x 85	20	24	34	2260	196	127	14	M8 x 22	37
60 x 90	20	24	34	2450	177	120	14	M8 x 22	37
65 x 95	20	24	34	3040	188	128	16	M8 x 22	37
70 x 110	24	28	40	4560	206	127	14	M10 x 25	70
75 x 115	24	28	40	4820	191	124	14	M10 x 25	70
80 x 120	24	28	40	5130	177	120	14	M10 x 25	70
85 x 125	24	28	40	6230	191	127	16	M10 x 25	70
90 x 130	24	28	40	6520	176	122	16	M10 x 25	70
95 x 135	24	28	40	7770	191	133	18	M10 x 25	70
100 x 145	26	33	47	9460	193	133	14	M12 x 30	127
110 x 155	26	33	47	10490	176	122	14	M12 x 30	127
120 x 165	26	33	47	12945	182	133	16	M12 x 30	127
130 x 180	34	38	52	17360	163	113	20	M12 x 35	127
140 x 190	34	38	52	20650	163	123	22	M12 x 35	127
150 x 200	34	38	52	23815	166	122	24	M12 x 35	127
160 x 210	34	38	52	27615	166	127	26	M12 x 35	127
170 x 225	38	44	60	32370	157	118	22	M14 x 40	195
180 x 235	38	44	60	37270	163	123	24	M14 x 40	195
190 x 250	46	52	68	45810	148	113	28	M14 x 45	195
200 x 260	46	52	68	51600	148	113	30	M14 x 45	195
220 x 285	50	56	74	66800	148	113	26	M16 x 50	290

SPANBUSSEN

TYPE KTN 45

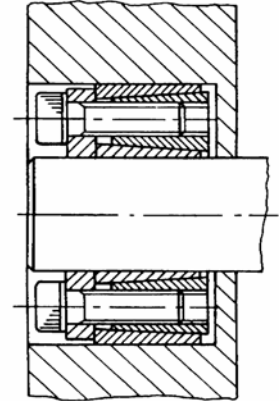
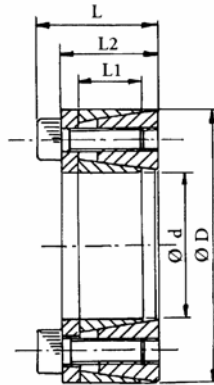
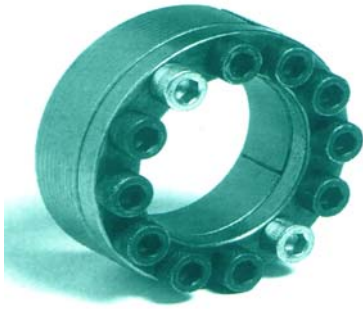

Dimensions of locking device				Torque	Surface pressure		Screws		
ø d x ø D	L1	L2	L		Nm	Shaft h8	Hub H8	per DIN 912 Mat. 12.9	
				N/mm ²		N/mm ²	N°	Type	Nm
18 x 40	12	18,5	24,5	190	260	120	6	M6 x 15	16
19 x 41	12	18,5	24,5	210	260	120	6	M6 x 15	16
20 x 42	12	18,5	24,5	240	250	120	6	M6 x 15	16
24 x 46	12	18,5	24,5	290	250	120	6	M6 x 15	16
25 x 47	12	18,5	24,5	330	230	120	8	M6 x 15	16
28 x 50	12	18,5	24,5	370	220	120	8	M6 x 15	16
30 x 52	12	18,5	24,5	430	210	120	8	M6 x 15	16
35 x 57	15	22	28	610	170	100	12	M6 x 15	16
38 x 60	15	22	28	680	170	100	12	M6 x 15	16
40 x 62	15	22	28	780	170	100	12	M6 x 15	16
42 x 70	18	28	36	1480	190	110	12	M8 x 22	41
45 x 73	18	28	36	1500	210	130	12	M8 x 22	41
48 x 76	18	28	36	1550	210	130	12	M8 x 22	41
50 x 78	18	28	36	1650	190	120	12	M8 x 22	41
55 x 83	18	28	36	2000	190	120	16	M8 x 22	41
60 x 88	18	28	36	2350	190	120	16	M8 x 22	41
70 x 105	22	35	45	3900	180	120	12	M8 x 25	70
80 x 115	22	35	45	4800	170	120	16	M10 x 25	70

SPANBUSSEN

TYPE KTN 50

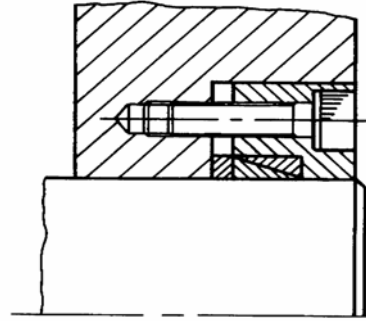
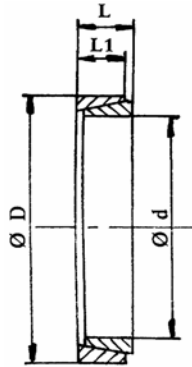

Dimensions of locking device			Force nec. KG	Torque Nm	Surface pressure	
Ø d x Ø D	L1	L			Shaft h8 N/mm ²	Hub H8 N/mm ²
6 x 9	3,7	4,5	380	2,4	115	75
7 x 10	3,7	4,5	390	3	105	70
8 x 11	3,7	4,5	530	4,7	120	90
9 x 12	3,7	4,5	1560	7,9	140	105
10 x 13	3,7	4,5	1560	9,5	135	105
12 x 15	3,7	4,5	1560	11,4	115	90
13 x 16	3,7	4,5	1560	13,1	110	90
14 x 18	5,3	6,3	2540	22,3	115	90
15 x 19	5,3	6,3	2540	24,3	110	85
16 x 20	5,3	6,3	2540	27,3	105	85
17 x 21	5,3	6,3	2540	29,8	105	85
18 x 22	5,3	6,3	2540	32,4	100	80
19 x 24	5,3	6,3	3600	49	140	110
20 x 25	5,3	6,3	3600	53	135	105
22 x 26	5,3	6,3	3600	66	135	115
24 x 28	5,3	6,3	3600	73	130	110
25 x 30	5,3	6,3	3600	72	115	95
28 x 32	5,3	6,3	3600	86	115	100
30 x 35	5,3	6,3	3600	91	100	85
32 x 36	5,3	6,3	4500	131	130	115
35 x 40	6	7	5400	171	125	110
36 x 42	6	7	5400	169	115	100
38 x 44	6	7	5400	181	110	95
40 x 45	6,6	8	6600	231	115	105
42 x 48	6,6	8	6600	235	110	95
45 x 52	8,6	10	9900	353	105	95
48 x 55	8,6	10	13200	572	155	135
50 x 57	8,6	10	13200	602	150	130
55 x 62	8,6	10	13200	670	140	125
56 x 64	10,4	12	15720	790	130	115
60 x 68	10,4	12	15720	860	125	110

TYPE KTN 70

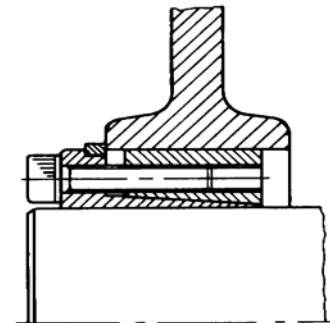
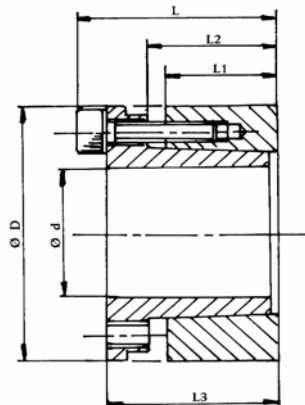

Dimensions of locking device					Torque Nm	Surface pressure		Screws		
ø d x ø D	L1	L2	L3	L		Shaft h8	Hub H8	per DIN 912 Mat. 12.9		
						N/mm ²	N/mm ²	N°	Type	Nm
19 x 47	26	31	39	45	353	228	98	4	M6 x 25	17
20 x 47	26	31	39	45	382	226	98	4	M6 x 25	17
22 x 47	26	31	39	45	431	215	93	4	M6 x 25	17
24 x 50	26	31	39	45	519	215	102	6	M6 x 25	17
25 x 50	26	31	39	45	578	225	102	6	M6 x 25	17
28 x 55	26	31	39	45	686	215	107	6	M6 x 25	17
30 x 55	26	31	39	45	745	196	117	6	M6 x 25	17
32 x 60	26	31	39	45	912	225	111	8	M6 x 25	17
35 x 60	26	31	39	45	1010	196	116	8	M6 x 25	17
38 x 65	26	31	39	45	1216	205	121	8	M6 x 25	17
40 x 65	26	31	39	45	1323	196	122	8	M6 x 25	17
42 x 75	30	36	47	55	2128	232	137	6	M8 x 30	41
45 x 75	30	36	47	55	2304	232	137	6	M8 x 30	41
48 x 80	30	36	47	55	2461	213	132	6	M8 x 30	41
50 x 80	30	36	47	55	2530	213	132	6	M8 x 30	41
55 x 85	30	36	47	55	3138	218	142	8	M8 x 30	41
60 x 90	30	36	47	55	3314	194	153	8	M8 x 30	41
65 x 95	30	36	47	55	4079	208	137	8	M8 x 30	41
70 x 110	40	46	57	67	6707	220	140	8	M10 x 35	83
75 x 115	40	46	62	72	7354	205	135	8	M10 x 35	83
80 x 120	40	46	62	72	7943	196	127	8	M10 x 35	83
85 x 125	40	46	62	72	9512	205	142	10	M10 x 35	83
90 x 130	40	46	62	72	10100	196	135	10	M10 x 35	83
95 x 135	40	46	62	72	11865	205	145	10	M10 x 35	83
100 x 145	46	52	77	89	15396	211	145	8	M12 x 45	145
110 x 155	46	52	77	89	16867	192	136	8	M12 x 45	145
120 x 165	46	52	77	89	22064	211	152	10	M12 x 45	145
130 x 180	46	52	77	89	23535	192	137	12	M12 x 45	145
140 x 190	51	59	84	90	30210	192	142	8	M14 x 45	230
150 x 200	51	59	84	90	36440	201	150	10	M14 x 45	230
160 x 210	51	59	84	90	39730	201	150	10	M14 x 45	230
170 x 225	51	59	84	90	40120	160	120	12	M14 x 45	230
180 x 235	51	59	84	90	40500	157	117	12	M14 x 45	230

TYPE KTN 71

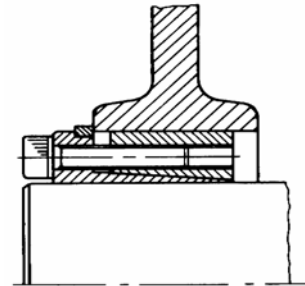
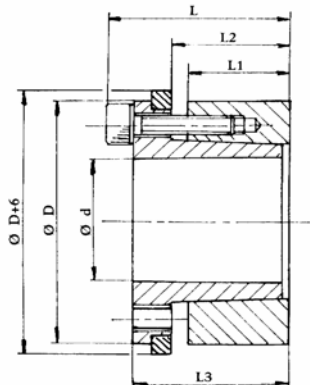

Dimensions of locking device					Torque Nm	Surface pressure		Screws		
ø d x ø D	L1	L2	L3	L		Shaft h8	Hub H8	per DIN 912 Mat. 12.9		
					N/mm ²	N/mm ²	N°	Type	Nm	
19 x 47	26	31	39	45	294	228	96	4	M6 x 25	17
20 x 47	26	31	39	45	313	226	96	4	M6 x 25	17
22 x 47	26	31	39	45	362	206	97	4	M6 x 25	17
24 x 50	26	31	39	45	421	206	100	6	M6 x 25	17
25 x 50	26	31	39	45	470	221	110	6	M6 x 25	17
28 x 55	26	31	39	45	578	202	105	6	M6 x 25	17
30 x 55	26	31	39	45	637	221	118	6	M6 x 25	17
32 x 60	26	31	39	45	784	197	114	8	M6 x 25	17
35 x 60	26	31	39	45	843	202	118	8	M6 x 25	17
38 x 65	26	31	39	45	1010	197	121	8	M6 x 25	17
40 x 65	26	31	39	45	1108	234	143	8	M6 x 25	17
42 x 75	30	36	47	55	1892	216	135	6	M8 x 30	41
45 x 75	30	36	47	55	1912	216	135	6	M8 x 30	41
48 x 80	30	36	47	55	2137	221	142	6	M8 x 30	41
50 x 80	30	36	47	55	2167	221	143	6	M8 x 30	41
55 x 85	30	36	47	55	2677	221	143	8	M8 x 30	41
60 x 90	30	36	47	55	2853	197	131	8	M8 x 30	41
65 x 95	30	36	47	55	3500	206	142	8	M8 x 30	41
70 x 110	40	46	57	67	5717	221	142	8	M10 x 35	83
75 x 115	40	46	62	72	6207	216	148	8	M10 x 35	83
80 x 120	40	46	62	72	6707	198	139	8	M10 x 35	83
85 x 125	40	46	62	72	8002	216	157	10	M10 x 35	83
90 x 130	40	46	62	72	8502	197	143	10	M10 x 35	83
95 x 135	40	46	62	72	10002	187	138	10	M10 x 35	83
100 x 145	46	52	77	89	13336	197	148	8	M12 x 45	145
110 x 155	46	52	77	89	14582	197	178	8	M12 x 45	145
120 x 165	46	52	77	89	19083	216	158	10	M12 x 45	145
130 x 180	46	52	77	89	20417	198	143	12	M12 x 45	145
140 x 190	51	59	84	90	24920	188	138	8	M14 x 45	230
150 x 200	51	59	84	90	30130	198	149	10	M14 x 45	230
160 x 210	51	59	84	90	32520	198	149	10	M14 x 45	230
170 x 225	51	59	84	90	33350	158	119	12	M14 x 45	230
180 x 235	51	59	84	90	33600	154	119	12	M14 x 45	230

SPANBUSSEN

TYPE KTN 80

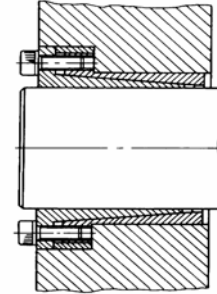
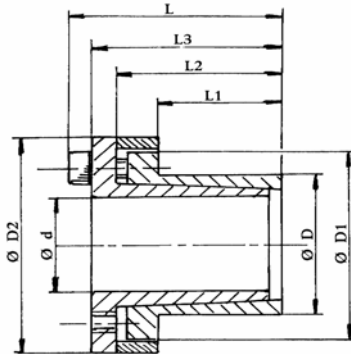
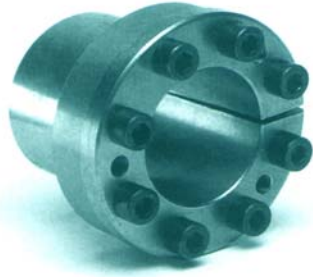

Dimensions of locking device						Torque Nm	Surface pressure		Screws		
ø d x ø D	ø D1 x ø D2	L1	L2	L3	L		Shaft h8	Hub H8	per DIN 912 Mat.12.9		
						N/mm ²	N/mm ²	N°	Type	Nm	
6 x 14	23 x 25	10	18,5	22,5	25,5	12	182	78	3	M3 x 10	2,2
8 x 15	24 x 27	12	21,5	25,5	29,5	28	198	104	3	M4 x 12	5
9 x 16	25 x 28	14	23,5	27,5	31,5	31	150	85	3	M4 x 12	5
10 x 16	25 x 28	14	23,5	27,5	31,5	35	135	85	3	M4 x 12	5
11 x 18	28 x 32	14	23,5	27,5	31,5	51	163	100	4	M4 x 12	5
12 x 18	28 x 32	14	23,5	27,5	31,5	56	151	100	4	M4 x 12	5
14 x 23	35 x 39	14	23,5	27,5	31,5	66	129	78	4	M4 x 12	5
15 x 24	40 x 45	16	29,5	35,6	42,5	175	189	135	4	M6 x 18	17
16 x 24	40 x 45	16	29,5	35,6	42,5	175	202	135	4	M6 x 18	17
18 x 26	42 x 47	19	32,5	39,5	45,5	196	180	124	4	M6 x 18	17
19 x 27	43 x 49	19	32,5	39,5	45,5	207	170	119	4	M6 x 18	17
20 x 28	44 x 50	19	32,5	39,5	45,5	219	161	115	4	M6 x 18	17
22 x 32	48 x 54	26	39,5	46,5	52,5	226	99	67	4	M6 x 18	17
24 x 34	50 x 56	26	39,5	46,5	52,5	392	146	102	6	M6 x 18	17
25 x 34	50 x 56	26	39,5	46,5	52,5	411	140	102	6	M6 x 18	17
28 x 39	55 x 61	25,5	39,5	46,5	52,5	460	125	90	6	M6 x 18	17
30 x 41	57 x 62	25,5	39,5	46,5	52,5	490	116	85	6	M6 x 18	17
32 x 43	59 x 65	25,5	39,5	46,5	52,5	701	146	108	8	M6 x 18	17
35 x 47	62 x 69	31,5	45,5	52,5	58,5	720	97	72	8	M6 x 18	17
38 x 50	66 x 72	31,5	45,5	52,5	58,5	781	90	68	8	M6 x 18	17
40 x 53	69 x 75	31,5	45,5	52,5	58,5	768	85	64	8	M6 x 18	17
42 x 55	71 x 78	31,5	45,5	52,5	58,5	863	80	64	8	M6 x 18	17
45 x 59	80 x 86	45	62,5	71	79	1711	100	76	8	M8 x 22	41
48 x 62	81 x 87	45	62,5	71	79	1824	93	72	8	M8 x 22	41
50 x 65	86 x 92	45	62,5	71	79	1902	90	68	8	M8 x 22	41
55 x 71	92 x 98	55	72,5	81	89	2353	75	58	9	M8 x 22	41
60 x 77	98 x 104	55	72,5	81	89	2569	68	53	9	M8 x 22	41
65 x 84	105 x 111	55	72,5	81	89	2786	63	53	9	M8 x 22	41
70 x 90	113 x 119	65	86,5	96,5	106,5	4755	79	61	9	M10 x 25	83
75 x 95	119 x 126	65	86,5	96,5	106,5	5100	73	57	9	M10 x 25	83
80 x 100	125 x 131	65	86,5	96,5	106,5	7250	92	57	12	M10 x 25	83
85 x 106	131 x 137	65	86,5	96,5	106,5	7700	86	57	12	M10 x 25	83
90 x 112	137 x 144	65	86,5	96,5	106,5	8160	81	57	12	M10 x 25	83
95 x 120	142 x 149	65	86,5	96,5	106,5	10800	98	80	14	M10 x 25	83
100 x 125	147 x 154	65	86,5	96,5	106,5	14800	118	93	18	M10 x 25	83

TYPE KTN 95

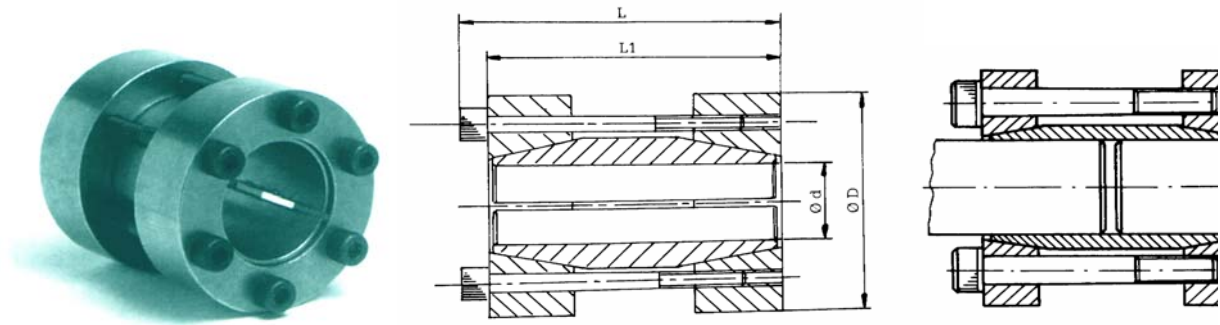

Dimensions of locking device				Torque Nm	Surface pressure		Screws		
ø d x ø D	L1	L			Shaft h8		per DIN 912 Mat. 12.9		
				N/mm ²	N°		Type	Nm	
17 x 50	50	56		200	110	4	M6 x 40	17	
18 x 50	50	56		220	110	4	M6 x 40	17	
19 x 50	50	56		230	110	4	M6 x 40	17	
20 x 50	50	56		240	105	4	M6 x 40	17	
24 x 55	60	66		290	120	4	M6 x 50	17	
25 x 55	60	66		450	110	6	M6 x 50	17	
28 x 60	60	66		510	110	6	M6 x 50	17	
30 x 60	60	66		550	105	6	M6 x 50	17	
32 x 63	60	66		580	90	6	M6 x 50	17	
35 x 75	75	83		760	105	4	M8 x 60	41	
38 x 75	75	83		850	100	4	M8 x 60	41	
40 x 75	75	83		900	95	4	M8 x 60	41	
42 x 78	75	83		930	90	4	M8 x 60	41	
45 x 85	85	93		1520	110	6	M8 x 70	41	
48 x 90	85	93		1600	100	6	M8 x 70	41	
50 x 90	85	93		1690	95	6	M8 x 70	41	
55 x 94	85	93		2430	110	8	M8 x 70	41	
60 x 100	85	93		2680	95	8	M8 x 70	41	
65 x 105	85	93		2900	90	8	M8 x 70	41	
70 x 115	100	110		3720	90	6	M10 x 80	83	
75 x 125	100	110		3970	80	6	M10 x 80	83	
80 x 125	100	110		4280	70	6	M10 x 80	83	